



wausauPAPER® PRODUCT GUIDE

wausauPAPER® PRODUCT GUIDE

CONTENTS

Total Facility Solutions	4
Industry Innovation	6
Towel and Tissue Products	
■ Artisan™	10
■ DublSoft®	12
■ DublNature®	14
■ EcoSoft™	18
■ Dubl-Tough®	24
■ Dari-Towls®	26
■ Windshield Towels	27
■ SIRRUS® Household Roll Towels	27
Controlled Towel Dispensing Systems	
■ Wave'n Dry®	30
■ OptiServ Hybrid®	30
■ OptiServ®	31
■ OptiServ Accent®	31
■ Controlled Roll Towels: Specifications	32
■ Hand Hygiene: Paper Towels vs. Air Dryers	33
■ Controlled Roll Towel Dispensing Systems	34
Universal Towel Dispensers	35

Controlled Bath Tissue Dispensing Systems	
■ Dubl-Serv® HC	38
■ Revolution®	40
■ Dubl-Serv® Vertical	40
■ Dubl-Serv® Side-by-Side	41
■ OptiCore® Adapter	41
■ OptiCore® Bath Tissue: Specifications	42
Universal Bath Tissue Dispensers	43
Hand Care Systems	
■ OptiSource® Non-Alcohol Foam vs. Alcohol Gel	44
■ OptiSource Convertible® Soap Products	46
■ OptiSource Convertible® Dispensing System	47
■ OptiSource® Hand Care System	48
■ Silhouette® Hand Care System	49
ADA Guidelines	50
Index by Catalog Number	52

Total Facility Solutions By Wausau Paper®

Wausau Paper offers a comprehensive line of premium and green products certified by Green Seal™ as well as complementary controlled-use dispensing systems for the away-from-home market. We offer unique brands of towel and tissue products: Artisan™, DublSoft®, DublNature® and EcoSoft™. Each brand, with its own unique attributes and benefits, offers customers high-quality products with exceptional performance.



The **Green Seal®** means that our products meet the most stringent and comprehensive environmental standard in our industry. In 2003, Wausau Paper became the first manufacturer to offer a complete line of towel and tissue products certified by Green Seal. Today, we have the most extensive line of Green Seal™-certified towel, tissue and soap products available in the away-from-home market.



These products meet Green Seal™ Standard GS-1 based on chlorine-free processing, energy and water efficiency, and content of 100% recovered material with a minimum of 50% post-consumer material for towels, 25% post-consumer material for bath tissue, and 15% post-consumer material for facial tissue. GreenSeal.org.



Controlled Roll Towel Systems

Wausau Paper controlled roll towel systems with pre-measured dispensing control costs and waste by reducing towel consumption 20% over uncontrolled roll towels.



Controlled Bath Tissue Systems

OptiCore® technology, combined with our Revolution® and Dubl-Serv® dispensing systems ensures maximum use of each roll in the dispenser before advancing to the next roll. This controlled use reduces product waste and cost.



Controlled Hand Care Systems

Wausau Paper provides comprehensive hand care systems that dispense foam or lotion soaps and instant hand sanitizer. The OptiSource Convertible® system is available in both electronic and manual configurations, meeting any facility's budget and needs.

GREEN SEAL STANDARDS FOR TOWEL AND TISSUE (GS-1)

- 100% Recycled (recovered after papermaking process) – may also contain a mix of agricultural plant residue
- Minimum 50% post-consumer wastepaper content for paper towels (exceeds EPA minimum guidelines)
- Minimum 25% post-consumer wastepaper content in bath tissue and toilet seat covers; 15% facial tissue (exceeds EPA minimum guidelines)
- Product performance is consistently measured under controlled and reproducible laboratory conditions and products meet the requirements in the standard with respect to basis weight, tensile strength, stretch, and absorbency
- Hardwound 1-ply roll towel contains a minimum of 133 square feet of product per roll; 58 square feet per roll minimum for 2-ply kitchen roll towels
- Folded 1-ply paper towel contains a minimum of 84 square feet per package
- 2-ply bath tissue contains a minimum of 41 square feet of product per roll and facial tissue contains a minimum of 37 square feet per package
- The papermaking process, including deinking and/or bleaching, for producing paper towels and tissue is processed chlorine free (PCF) and does not contain any additives or contaminants that are carcinogens, mutagens or reproductive toxins
- The papermaking process meets the established limits for water disinfection and optical brighteners
- Papermaking additives are readily biodegradable, except for those noted in the standard
- Paper towels or bath tissue do not contain any added chlorophenolic biocides, fragrances, heavy metals, or ozone-depleting compounds
- Products are manufactured by companies that adhere to social responsibility guidelines and provide fair conditions of employment
- Products are manufactured within established annual water and energy use criteria
- The cores in the roll towels and bath tissue and the facial tissue boxes are made from 100% recycled materials
- Outer corrugated cardboard packaging is recyclable and made from at least 30% recovered material
- Packaging made from plastic is recyclable, or source-reduced by 20% or contains 25% recovered material content
- Packaging does not contain heavy metals, including lead, mercury, cadmium, and hexavalent chromium nor phthalates, bisphenol A, and chlorinated packaging material (for plastic packaging) that have intentionally been introduced
- Printing colorants on packaging do not contain lead, mercury, cadmium, and hexavalent chromium in excess of 100 parts per million (above trace levels)

Industry Innovation By Wausau Paper®

Wausau Paper leverages its expertise in green products with ATMOS papermaking technology to create unique product solutions for the away-from-home industry. This flexible papermaking process utilizes carefully chosen structured fabrics to produce premium Green Seal™-certified products designed for enhanced performance and appearance. This allows Wausau Paper to offer green towel and tissue products with exceptional plushness, brightness, strength and absorbency.

Structured for Sustainability and Quality

Wausau Paper chose to align with a technology that produces high-quality towel and tissue products while supporting sustainability. Allowing the use of 100% recycled fibers, ATMOS is environmentally superior to alternative papermaking technologies including Through-Air-Dried (TAD). With Wausau Paper's molding fabrics, paper products are also plush, soft, highly absorbent, and best of all, Green Seal™-certified.

Fashionably Formed

Wausau Paper's new tissue formation process derived from ATMOS technology known as Fusion® is designed to provide premium bath tissue with exceptional plushness, softness and brightness. Featuring the beauty of consumer tissue, Fusion® formation bath tissue sets a standard, which is not easily surpassed. Fusion® tissue marries both feel and function to satisfy the most discerning customers.

Authentically Green®

All Wausau Paper towels and tissue designed with ATMOS are certified as environmentally preferable by Green Seal, meeting comprehensive and strict guidelines for manufacture. Only Wausau Paper combines innovative papermaking and the finest quality fibers with the leading green certification to provide the most sustainable solution in premium towels and tissue.



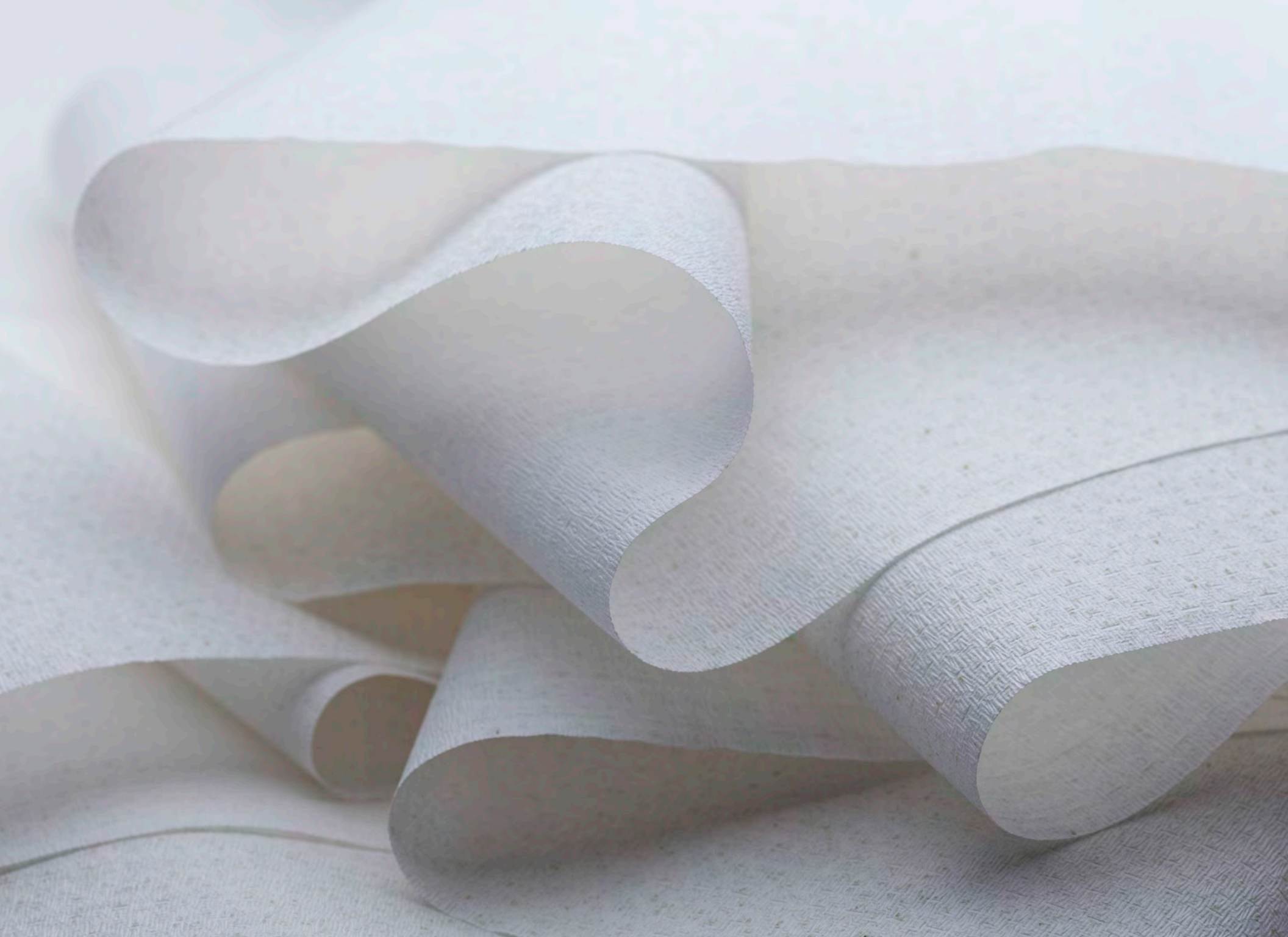

Artisan[™]

DublSoft[®]

 **DublNature**[®]

EcoSoft[™]

**TOWEL
AND
TISSUE**

Artisan™

Premium Towel Products Certified by Green Seal™



Artisan™ Premium Towels

Artisan™ offers superior sophistication for your hand drying experience. Carefully crafted from innovative ATMOS papermaking technology, toweling is brilliant white, remarkably strong, yet soft enough to provide a comforting hand drying experience. Artisan™ caters to upscale properties such as Class A office buildings, high-end lodging establishments, and healthcare facilities. Artisan™ possesses Green Seal™ certification along with luxury that is authentically designed for the refined.

Artisan™ Premium Roll Towels



Superior quality Artisan™ roll towels are designed for a premium hand drying experience. Toweling is brilliant white for a clean, hygienic appearance. Artisan™ cloth-like towels appeal to facilities that seek exceptional quality products that reinforce an upscale image. When coupled with Wausau Paper® controlled-use dispensing systems, Artisan™ towels save money by reducing waste and maintenance costs. Roll towels are available in lengths of 425 or 600 feet.

Artisan™ Premium Folded Towels





Each Artisan™ towel features a unique surface design for beauty and performance. These extra thick towels absorb wetness quickly – minimizing the amount of towels needed for hand dries. Artisan™ premium quality folded towels have neutral upscale packaging and are ideal for high-end facilities. Towels are available in traditional multifold and C-fold configurations as well as uniquely sized OptiFold® to satisfy any hand drying application.



Controlled Roll Towels

No.		Name	Color	Dispenser	Roll Width	Feet/Roll	Rolls/Case	Feet/Case	Cases/Unit	Cases/ Even Layer	Average Case Cube
30620		Artisan™	White	80010, 87510, 86800	8"	600	6	3,600	55	5	1.93
30320		Artisan™	White	80010, 87510, 86800	8"	425	6	2,550	55	5	1.91

Folded Towels

No.		Name	Color	Dispenser	Sheet Size (W" x L")	Towels/Package	Packages/Case	Towels/Case	Cases/Unit	Cases/ Even Layer	Average Case Cube
04220		Artisan™ Multifold	White	53200, 53500	9½ x 9½	250	12	3,000	54	6	1.48
04820		Artisan™ C-Fold	White	53200, 53500	10½ x 13	150	16	2,400	48	6	1.88
04420		Artisan™ OptiFold®	White	53200, 53500	10¼ x 9½	250	12	3,000	56	7	1.69
04620		Artisan™ OptiFold® ES	White	53200, 53500	8 x 9½	250	12	3,000	66	6	1.31

DublSoft®

Premium Tissue Products

DublSoft® Premium Bath Tissue

DublSoft® bath tissue features consumer-like floral embossing for exceptional softness. Universal tissue is available in 500 sheet count and a 400 sheet count to satisfy any facility's need. The OptiCore® tissue provides optimum savings in maintenance time and costs when combined with our OptiCore® dispensing systems.



DublSoft® Premium Facial Tissue

DublSoft® facial tissue offers superior softness for the most discriminating customers. Facial tissue features a blue food grade dye line to notify that product is low, thereby saving maintenance time. The stylish contemporary packaging makes the flat or cubed box facial an attractive addition to any décor.



Controlled Bath Tissue

No.	Name	Ply	Dispenser	Sheet Size (W" x L")	Sheets/Roll	Rolls/Case	Sheets/Case	Cases/Unit	Cases/ Even Layer	Average Case Cube
06390	DublSoft® OptiCore®	Double	80200, 80300, 82300	3¾ x 4	800	36	28,800	48	6	2.74
06325	DublSoft®	Double	72300, 72600, 88400	3¾ x 4	625	48	30,000	36	6	2.88

Universal Bath Tissue

No.	Name	Ply	Dispenser	Sheet Size (W" x L")	Sheets/Roll	Rolls/Case	Sheets/Case	Cases/Unit	Cases/ Even Layer	Average Case Cube
06348	DublSoft®	Double	72200	4¾ x 4	500	48	24,000	45	9	2.58
06380	DublSoft®	Double	72200	4¾ x 4	500	80	40,000	20	4	3.99
06480	DublSoft®	Double	72200	4¾ x 4	400	80	32,000	20	4	3.99

Facial Tissue

No.	Name	Ply	Box	Sheet Size (W" x L")	Sheets/Box	Boxes/Case	Sheets/Case	Cases/Unit	Cases/ Even Layer	Average Case Cube
06100	DublSoft® Flat	Double	Flat	8 x 8	100	30	3,000	56	8	1.47
06185	DublSoft® Cube	Double	Cube	8 x 8	85	36	3,060	42	6	2.39

DublNature®

High-Quality Paper Products Certified by Green Seal™



DublNature® Towels and Tissue

DublNature® products are manufactured with ATMOS technology and designed for comfort and functionality. DublNature® provides versatility and is ideal for office buildings, lodging establishments, healthcare facilities, restaurants, and colleges/universities. Offering the best in quality without sacrificing green sensibilities, DublNature® offers a premium Green Seal™ experience.

DublNature® Roll Towels

DublNature® roll towels offer the softness and strength needed to elevate your hand-drying experience. DublNature® features a unique weave pattern creating highly absorbent towels so fewer are needed per hand dry. And with such exceptional brightness, you'll hardly believe DublNature® roll towels are made from 100% recycled fibers and Green Seal™-certified. Towels are available in lengths of 450', 600', 800' and 1,000' with controlled and universal options.



DublNature® Folded Towels

DublNature® folded towels are designed for performance and offer superior strength, absorbency and softness. Folded towels are made from high-class 100% recycled fibers and contain a minimum of 50% post-consumer waste. Available in multifold, C-fold and OptiFold® configurations, there is a DublNature® folded towel that meets any facility's need.







DublNature® Bath and Facial Tissue



DublNature® tissue is Green Seal™-certified with upscale packaging to promote a premium green image. Offering the beauty of consumer bath tissue, DublNature® features rounded quilt and floral embossing. Bath tissue is designed with a unique Fusion® formation process providing exceptional plushness and softness. Cube or flat box facial tissue has an aesthetically pleasing design that complements any décor. DublNature® bath and facial tissue are ideal for establishments seeking a premium green image.





Controlled Roll Towels

No.		Name	Color	Dispenser	Roll Width	Feet/Roll	Rolls/Case	Feet/Case	Cases/Unit	Cases/ Even Layer	Average Case Cube
31040		DublNature®	White	80010, 87510, 86800	8"	1,000	6	6,000	55	5	1.91
38040		DublNature®	White	80010, 87510, 86800	8"	800	6	4,800	55	5	1.91
36040		DublNature®	White	80010, 87510, 86800	8"	600	6	3,600	55	5	1.91
34540		DublNature®	White	86600, 80010, 87510, 86800	8"	450	12	5,400	48	8	2.13





Universal Roll Towels

No.		Name	Color	Dispenser	Roll Width	Feet/Roll	Rolls/Case	Feet/Case	Cases/Unit	Cases/ Even Layer	Average Case Cube
44040		DublNature®	White	16000	8"	1,000	6	6,000	55	5	1.91
44840		DublNature®	White	16000	8"	800	6	4,800	55	5	1.91

CenterPull Roll Towels



No.		Name	Color	Dispenser	Sheet Size (W" x L")	Feet/Roll	Rolls/Case	Feet/Case	Cases/Unit	Cases/ Even Layer	Average Case Cube
60040		DublNature®	White	68100	7 x 12	600	4	2,400	78	6	1.13

Folded Towels







No.		Name	Color	Dispenser	Sheet Size (W" x L")	Towels/Package	Packages/Case	Towels/Case	Cases/Unit	Cases/ Even Layer	Average Case Cube
48140		DublNature® Multifold	White	53200, 53500	9½ x 9½	250	16	4,000	60	6	1.89
49140		DublNature® C-Fold	White	53200, 53500	10½ x 13	150	16	2,400	48	6	1.88
48440		DublNature® OptiFold®	White	53200, 53500	10¼ x 9½	250	12	3,000	56	7	1.61
48640		DublNature® OptiFold® ES	White	53200, 53500	8 x 9½	250	12	3,000	66	6	1.24

DublNature®

Controlled Bath Tissue

No.	Name	Ply	Dispenser	Sheet Size (W" x L")	Sheets/Roll	Rolls/Case	Sheets/Case	Cases/Unit	Cases/Even Layer	Average Case Cube
62040	 DublNature® OptiCore®	Fusion® Formation	80200, 80300, 82300	3¾ x 4	865	36	31,140	48	6	2.54
62090	 DublNature® OptiCore®	Double	80200, 80300, 82300	3¾ x 4	865	36	31,140	48	6	2.74

Universal Bath Tissue

No.	Name	Ply	Dispenser	Sheet Size (W" x L")	Sheets/Roll	Rolls/Case	Sheets/Case	Cases/Unit	Cases/Even Layer	Average Case Cube
55040	 DublNature®	Fusion® Formation	72200	4¾ x 4	550	80	44,000	30	6	4.25
55440	 DublNature®	Fusion® Formation	72200	4 x 4	550	48	26,400	45	9	2.37
55840	 DublNature®	Fusion® Formation	72200	4 x 4	550	80	44,000	30	6	3.91
50940	 DublNature®	Fusion® Formation	72200	4 x 3¾	500	96	48,000	25	5	4.68
59490	 DublNature®	Double	72200	4¾ x 3¾	500	48	24,000	45	9	2.58
59890	 DublNature®	Double	72200	4¾ x 3¾	500	80	40,000	30	6	4.26

Facial Tissue

No.	Name	Ply	Box	Sheet Size (W" x L")	Sheets/Box	Boxes/Case	Sheets/Case	Cases/Unit	Cases/Even Layer	Average Case Cube
08540	 DublNature®	Double	Cube	8 x 8	85	36	3,060	42	6	2.39
10040	 DublNature®	Double	Flat	8 x 8	100	30	3,000	56	8	1.47



EcoSoft™

100% Recycled and Green Seal™-certified Paper Products



EcoSoft™ Roll Towels

EcoSoft™ roll towels satisfy those who prefer to purchase quality towels produced with methods less harmful to the environment. These roll towels are 100% recycled, meet or exceed EPA guidelines for post-consumer wastepaper content, and many are Green Seal™-certified. Available in white, natural white and natural, EcoSoft™ roll towels provide waste reduction and cost savings benefits.

EcoSoft™ Folded Towels

EcoSoft™ folded towels are 100% recycled and available in singlefold, multifold and C-fold and OptiFold® configurations. Most folded towels are certified as environmentally preferable by Green Seal, Inc. of Washington, DC.

EcoSoft™ Bath Tissue

Embossed for softness, EcoSoft™ tissues provides the quality users expect. EcoSoft™ tissue is offered in single and double ply and designed for use with our controlled-use, universal, and jumbo dispensing systems. Available in 100% recycled and Green Seal™-certified options.

EcoSoft™ Facial Tissue

EcoSoft™ facial tissue is soft, made of 100% recycled fiber and meets or exceeds EPA guidelines for post-consumer wastepaper content. Facial tissue offers the feel of household tissue with attractive, environmentally preferable packaging.

EcoSoft™ Household Roll Towels





EcoSoft™ household roll towels are heavily embossed for superior absorbency and performance with the wet strength needed for use in business and industry. Available in a variety of sheet counts and Green Seal™-certified options available.

EcoSoft™ Toilet Seat Covers

EcoSoft™ toilet seat covers provide maximum sanitary protection and are Green Seal™-certified.



Controlled Roll Towels









No.	Name	Color	Dispenser	Roll Width	Feet/Roll	Rolls/Case	Feet/Case	Cases/Unit	Cases/ Even Layer	Average Case Cube
31000	 EcoSoft™	Natural	80010, 86800, 87510, 89400, 89500	8"	1,000	6	6,000	55	5	1.81
31300	 EcoSoft™	Natural	80010, 86800, 87510, 89400, 89500	8"	800	6	4,800	55	5	1.81
31400	 EcoSoft™	Natural White	80010, 86800, 87510, 89400, 89500	8"	800	6	4,800	55	5	1.89
31060	 EcoSoft™	Natural	80010, 86600, 86800, 87510 89400, 89500	8"	550	6	3,300	88	8	1.16
21400	 EcoSoft™	Natural White	80010, 86600, 86800, 87510 89400, 89500	8"	425	12	5,100	48	8	2.22
31900	EcoSoft™	White	80010, 86800, 87510, 89400, 89500	8"	800	6	4,800	55	5	1.81
31500	EcoSoft™	Natural	80010, 86800, 87510, 89400, 89500	8"	630	6	3,780	55	5	1.86
31600	EcoSoft™	White	80010, 86800, 87510, 89400, 89500	8"	630	6	3,780	55	5	1.86
20100	EcoSoft™	Natural	86600	8"	425	12	5,100	48	8	2.22
25200	EcoSoft™ Cub-Towels®	White	55000	8"	168	20	3,360	66	6	1.91

CenterPull Roll Towels









No.	Name	Color	Ply	Roll Width Sheet Size (W" x L")	Feet/Roll	Rolls/Case	Feet/Case	Cases/Unit	Cases/ Even Layer	Average Case Cube
06002	 EcoSoft™	White	Double	7 x 12	600	6	3,600	60	5	1.70

EcoSoft™





Universal Roll Towels

No.	Name	Color	Dispenser	Roll Width (Sheet Size)	Feet/Roll	Rolls/Case	Feet/Case	Cases/Unit	Cases/ Even Layer	Average Case Cube
45800	 EcoSoft™	Natural	16000	8"	800	6	4,800	55	5	1.81
45900	 EcoSoft™	Natural White	16000	8"	800	6	4,800	55	5	1.81
46000	 EcoSoft™	Natural	16000	8"	425	12	5,100	42	7	2.50
46300	 EcoSoft™	Natural White	16000	8"	425	12	5,100	42	7	2.50
45600	 EcoSoft™	Natural White	16000	8"	350	12	4,200	48	8	2.04
46200	 EcoSoft™	Natural	16000	8"	350	12	4,200	48	8	2.04
46800	 EcoSoft™	Natural	16000	8"	205	24	4,920	54	9	2.47
46900	 EcoSoft™	Natural White	16000	8"	205	24	4,920	54	9	2.47
45700	EcoSoft™	White	16000	8"	800	6	4,800	55	5	1.89
46500	EcoSoft™	White	16000	8"	425	12	5,100	42	7	2.50
45500	EcoSoft™	White	16000	8"	350	12	4,200	48	8	2.04

Folded Towels

No.		Name	Color	Dispenser	Sheet Size (W" x L")	Towels/Package	Packages/Case	Towels/Case	Cases/Unit	Cases/Even Layer	Average Case Cube
48000		EcoSoft™ Multifold	Natural	53200, 53500	9½ x 9½	250	16	4,000	70	7	1.55
48300		EcoSoft™ Multifold	Natural White	53200, 53500	9½ x 9½	250	16	4,000	70	7	1.55
47000		EcoSoft™ Singlefold	Natural	53200, 53500	9 x 10	250	16	4,000	60	6	1.90
47300		EcoSoft™ Singlefold	Natural White	53200, 53500	9 x 10	250	16	4,000	60	6	1.90
48890		EcoSoft™ OptiFold®	Natural White	53200, 53500	10¼ x 9½	250	16	4,000	63	7	1.73
48790		EcoSoft™ OptiFold® ES	Natural White	53200, 53500, 53800	8 x 9½	250	16	4,000	77	7	1.38
49300		EcoSoft™ C-Fold	Natural White	53200, 53500	10½ x 13	200	12	2,400	72	8	1.47
48500		EcoSoft™ Multifold	White	53200, 53500	9½ x 9½	250	16	4,000	70	7	1.55
47500		EcoSoft™ Singlefold	White	53200, 53500	9 x 10	250	16	4,000	60	6	1.90
49500		EcoSoft™ C-Fold	White	53200, 53500	10½ x 13	200	12	2,400	72	8	1.47

Household Roll Towels

No.		Name	Ply	Sheet Size (W" x L")	Sheets/Roll	Rolls/Case	Sheets/Case	Cases/Unit	Cases/Even Layer	Average Case Cube
40090		EcoSoft™	Double	11 x 9	100	30	3,000	24	6	4.21
41090		EcoSoft™	Double	11 x 9	90	30	2,700	24	6	4.21
41859		EcoSoft™	Double	11 x 9	85	30	2,550	24	6	4.21
40000		EcoSoft™	Double	11 x 9	100	30	3,000	24	6	4.21
41000		EcoSoft™	Double	11 x 9	90	30	2,700	24	6	4.21
41080		EcoSoft™	Double	11 x 9	80	30	2,400	24	6	4.21

EcoSoft™

Silhouette® Toilet Seat Cover Dispenser (10/Case)

No.	Dispenser Size (W" x H" x D")	Dispenser Weight	Case Size (W" x H" x D")	Cases/Unit	Average Case Cube
19510 Black	16 $\frac{1}{8}$ x 11 $\frac{1}{8}$ x 3 $\frac{1}{8}$	1 lbs.	24 $\frac{3}{4}$ x 17 $\frac{7}{8}$ x 13 $\frac{1}{8}$	28	2.3



	Red Translucent: 19513
	Green Translucent: 19514
	Blue Translucent: 19515
	White Translucent: 19516

Toilet Seat Covers

No.	Name	Dispenser	Sheet Size (W" x L")	Sheets/Package	Packages/Case	Sheets/Case	Cases/Unit	Cases/ Even Layer	Average Case Cube
19490	EcoSoft™	19510	14 $\frac{1}{2}$ x 17	250	20	5,000	50	10	1.47







Facial Tissue

No.	Name	Ply	Sheet Size (W" x L")	Sheets/Box	Boxes/Case	Sheets/Case	Cases/Unit	Cases/ Even Layer	Average Case Cube
15000	EcoSoft™	Double	8 x 8	160	30	4,800	48	6	2.22
13000	EcoSoft™	Double	8 x 8	100	30	3,000	56	8	1.47





Controlled Bath Tissue

No.	Name	Ply	Dispenser	Sheet Size (W" x L")	Sheets/Roll	Rolls/Case	Sheets/Case	Cases/Unit	Cases/ Even Layer	Average Case Cube
60090	EcoSoft™ High-Capacity OptiCore®	Double	80400	3 $\frac{3}{4}$ x 3 $\frac{1}{2}$	2,000	12	24,000	60	5	1.60
12990	EcoSoft™ OptiCore®	Single	80200, 80300, 82300	3 $\frac{3}{4}$ x 4	1,755	36	63,180	48	6	2.74
61990	EcoSoft™ OptiCore®	Double	80200, 80300, 82300	3 $\frac{3}{4}$ x 4	865	36	31,140	48	6	2.74
12300	EcoSoft™	Single	72300, 72600, 88400	3 $\frac{3}{4}$ x 4	1,232	48	59,136	36	6	2.88
61600	EcoSoft™	Double	72300, 72600, 88400	3 $\frac{3}{4}$ x 4	616	48	29,568	36	6	2.88

Universal Bath Tissue

No.		Name	Ply	Dispenser	Sheet Size (W' x L')	Sheets/Roll	Rolls/Case	Sheets/Case (Feet)	Cases/Unit	Cases/Even Layer	Average Case Cube
14800		EcoSoft™	Single	72200	4 ³ / ₈ x 3 ³ / ₄	1,000	48	48,000	45	9	2.50
54900		EcoSoft™	Double	72200	4 ³ / ₈ x 3 ³ / ₄	500	96	48,000	25	5	4.79
14000		EcoSoft™	Single	72200	4 x 3 ³ / ₄	1,000	96	96,000	25	5	4.68
50080		EcoSoft™	Double	72200	4 x 3 ³ / ₄	500	80	40,000	30	6	3.92
54000		EcoSoft™	Double	72200	4 x 3 ³ / ₄	500	96	48,000	25	5	4.68
54800		EcoSoft™	Double	72200	4 x 3 ³ / ₄	500	48	24,000	45	9	2.37
11500		EcoSoft™	Single	72200	4 x 4 ¹ / ₂	1,500	60	90,000	30	6	4.01
10000		EcoSoft™	Single	72200	4 x 4 ¹ / ₂	1,000	96	96,000	25	5	4.68
50000		EcoSoft™	Double	72200	4 x 4 ¹ / ₂	500	96	48,000	25	5	4.68

Jumbo Roll Bath Tissue

No.		Name	Ply	Dispenser	Sheet Size (W' x L')	Sheets/Roll	Rolls/Case	Sheets/Case (Feet)	Cases/Unit	Cases/Even Layer	Average Case Cube
02001		EcoSoft™	Single	88700, 88800, 88900	3 ¹ / ₂ x 2,000'	–	12	(24,000)	54	6	2.04
10020		EcoSoft™	Double	88700, 88800, 88900	3 ¹ / ₂ x 1,000'	–	12	(12,000)	54	6	2.04
20020		EcoSoft™	Double	88700	3 ¹ / ₂ x 2,000'	–	6	(12,000)	54	6	1.89
40010		EcoSoft™	Single	88700	3 ¹ / ₂ x 4,000'	–	6	(24,000)	54	6	1.89

Dubl-Tough®

Industrial Wipers

Dubl-Tough® industrial wipers provide versatility ranging from light to heavy-duty applications. Dubl-Tough® wipers are strong, soft and absorbent and are offered in a variety of substrates and packaging configurations.



Heavy Duty: Ultra Dubl-Tough®

- Available in double recycle (DRC) substrate
- Perfect for absorbing liquids and leaves surfaces streak-free
- Ideal for use with chemical solvents

Multiple Duty: Multi Dubl-Tough®

- Maximum absorbency (8 times its weight in grease, oil, and ink)
- Airlaid wiper is solvent resistant
- Perfect for general clean-up

Single Duty: Mightly Dry Dubl-Tough®

- Maximum strength, absorbency and softness
- Ideal for light oil, dirt and water
- Virtually lint free

Ultra Dubl-Tough®

No.	Grade	Color	Packaging	Sheet Size (W" x L")	Wipers/Package	Packages/Case	Wipers/Case	Cases/Unit	Cases/Even Layer	Average Case Cube
03380	DRC Wiper	White	1/4 Fold Poly	12¼ x 13	50	20	1,000	42	6	2.14

Multi Dubl-Tough®

No.	Grade	Color	Packaging	Sheet Size (W" x L")	Wipers/Package	Packages/Case	Wipers/Case	Cases/Unit	Cases/Even Layer	Average Case Cube
03351	Premium Airlaid	White	1/4 Fold Poly	12½ x 13¼	35	20	700	56	8	2.07
03352	Economy Airlaid	White	1/4 Fold Poly	12½ x 13¼	35	20	700	54	9	1.29
03356	Economy Airlaid	White	CenterPull	8 x 11 ¹¹ / ₆	400	6	2,400	50	10	1.74

Mighty Dry Dubl-Tough®

No.	Grade	Color	Packaging	Sheet Size (W" x L")	Wipers/Package	Packages/Case	Wipers/Case	Cases/Unit	Cases/Even Layer	Average Case Cube
03362	Scrim Paper	White	Pop-Up Box	9¾ x 16¾	125	8	1,000	48	8	2.12

Dari-Towels®

Single-use Wausau Paper® Dari-Towels® protect profits by helping control the spread of infectious mastitis. More sanitary than rags or sponges, Dari-Towels® provide a set of clean, absorbent prep towels for each cow, minimizing the chance of cross-contamination in the herd.



Scrub/Wash Dari-Towels®

Wausau Paper 35000 and 36000 Dari-Towels® feature superior wet strength to thoroughly scrub and clean each cow before milking.



General Purpose Dari-Towels®

The 47010 and 25000 Dari-Towels® offer versatility for wiping and drying. Made entirely from 100% recovered fibers, 47010 and 25000 Dari-Towels® offer an alternative for environmentally-conscious dairy farms.



Pre-Dip Dari-Towels®

Used regularly, pre-dip towels safeguard the herd and reduce the spread of infectious mastitis. This helps to minimize veterinary expenses and lower overall operating costs.

No.	Name	Color	Dispenser	Sheet Size (W" x L")	Towels/Package	Packages/Case	Towels/Case	Cases/Unit	Cases/Even Layer	Average Case Cube
25000	Dari-Towels® (2-Ply)	Natural White	53200, 53500, 51000	9 x 10	150	15	2,250	60	6	1.91
34000	Pre-Dip Dari-Towels®	Natural	53200, 53500, 51000	9 x 10	268	10	2,680	72	8	1.40
35000	Dari-Towels®	Natural	53200, 53500, 51000	9 x 10	268	15	4,020	50	5	2.09
36000	Dari-Towels®	Natural	53200, 53500, 51000	9 x 10	250	8	2,000	48	12	0.89
39000	Dari-Towels®	White	53200, 53500, 51000	9 x 10	168	12	2,016	81	9	1.26
47010	Dari-Towels®	Natural	53200, 53500, 51000	9 x 10	250	16	4,000	60	6	1.91

Windshield towels

Windshield towels from Wausau Paper® absorb wetness quickly and thoroughly without falling apart.



Singlwipes®

- For lighter duty applications
- Economical alternative to 53000 towels
- Available in blue



Twinwipes®

- For heavy-duty applications
- Increased absorbency/wet strength
- Available in blue and natural white

Windshield Towels

No.	Name	Ply	Color	Dispenser	Sheet Size (W" x L')	Towels/Package	Packages/Case	Towels/Case	Cases/Unit	Cases/Even Layer	Average Case Cube
13400	Singlwipes®	1	Blue	53200, 53500	9 x 10	250	8	2,000	48	12	1.10
52500	Twinwipes®	2	Natural White	53200, 53500	9 x 10	150	15	2,250	60	6	1.91
53000	Twinwipes®	2	Blue	53200, 53500	9 x 10	150	15	2,250	60	6	1.91

Sirrus® Household Roll Towels

No.	Name	Ply	Sheet Size (W" x L")	Sheets/Roll	Rolls/Case	Sheets/Case	Cases/Unit	Cases/Even Layer	Average Case Cube
40700	Sirrus®	2	11 x 9	70	30	2,100	24	6	4.21
40900	Sirrus®	2	11 x 9	90	30	2,700	24	6	4.21

Sirrus®

Household Roll Towels



Sirrus® Household Roll Towels

Sirrus® household roll towels feature packaging compliant for retail sale. Sirrus® household toweling is heavily embossed, soft and absorbent. Made entirely from recovered fibers.



wave'nDRY®

optiSERV^{hybrid}®

optiSERV®

optiSERV^{accent}®





CONTROLLED

TOWEL

DISPENSING

SYSTEM

No. 80010

Description Wave'n Dry®
Translucent Color Black
Dispenser Size (W" x H" x D") 12 x 15 $\frac{1}{8}$ x 10 $\frac{3}{8}$
Dispenser Weight 8.2 lbs.
Case Size (W" x H" x D") 16 $\frac{3}{8}$ x 12 $\frac{3}{8}$ x 12 $\frac{3}{8}$
Cases/Unit 48
Average Case Cube 1.42

 80020 Water Resistant
 80030
 80040
 80050
 80060

wave'nDRY®



Electronic Convenience for Automated Washrooms





The Wave'n Dry® dispenser is a pioneer in the touch-free towel dispensing market. With no levers, buttons or cranks, the Wave'n Dry® dispenses a single towel at the wave of a hand, ensuring that the only thing you touch is your personal towel. Towels are stored fully protected inside the dispenser until you request service, which is particularly important in public washrooms, food preparation areas and healthcare environments where prevention of cross-contamination is critical.

Controlled-Use Dispensing

Tailor dispensing to your facility's needs by choosing a pre-set towel length of 8", 11", 16 $\frac{1}{2}$ ", or 22" and choose the optimal settings for delay between cycles and sensor sensitivity to prevent waste while meeting user needs.

No. 87510

Description OptiServ Hybrid®
Translucent Color Black
Dispenser Size (W" x H" x D") 12 $\frac{1}{8}$ x 16 $\frac{13}{16}$ x 9 $\frac{13}{16}$
Dispenser Weight 9.35 lbs.
Case Size (W" x H" x D") 16 $\frac{7}{8}$ x 10 $\frac{1}{8}$ x 12 $\frac{1}{4}$
Cases/Unit 100
Average Case Cube 1.21

 87530
 87540
 87550
 87560

optiSERV^{hybrid}®







Flexibility Built Into a Functional and Attractive Design

Unique and elegant, the OptiServ Hybrid® offers the benefits of electronic touch-free dispensing as well as the convenience of mechanical dispensing when desired. In either mode the OptiServ Hybrid® delivers a single pre-measured towel that encourages users to take only what is needed to reduce waste making it ideal for office buildings, colleges and universities and high-traffic washrooms.

Controlled-Use Dispensing

Metered dispensing discourages waste and controls cost. A locking cover prevents pilferage.

No.	86800
	
Description	OptiServ®
Translucent Color	Black
Dispenser Size (W" x H" x D")	12 ¹ / ₈ x 16 ¹³ / ₁₆ x 9 ¹³ / ₁₆
Dispenser Weight	6.85 lbs.
Case Size (W" x H" x D")	16 ¹ / ₈ x 10 ¹ / ₈ x 12 ¹ / ₄
Cases/Unit	100
Average Case Cube	1.21

	86830
	86840
	86850
	86860

optiSERV®







Rugged Reliability for High-Traffic Washrooms

The OptiServ® hands-free dispensing system offers the hygiene of hands-free dispensing without need for batteries. The OptiServ® is easy to use and accommodates up to 1,000 feet of toweling, making it ideal for high-traffic facilities where cleanliness is essential.

Controlled-Use Dispensing

Each pull of the exposed towel dispenses and cuts a single 11-inch towel to discourage waste and control cost. A locking cover prevents pilferage.

No.	86600
	
Description	OptiServ Accent®
Translucent Color	Black
Dispenser Size (W" x H" x D")	12 ³ / ₁₆ x 12 ⁵ / ₈ x 7 ¹ / ₂
Dispenser Weight	5.65 lbs.
Case Size (W" x H" x D")	12 ³ / ₄ x 12 ⁵ / ₈ x 7 ³ / ₄
Cases/Unit	144
Average Case Cube	0.72

	86630
	86640
	86650
	86660

optiSERV^{accent}®













The Perfect Solution for Small Spaces

The OptiServ Accent® is ideal for environments where space is limited. Designed to fit tight spaces previously reserved for folded towels, the OptiServ Accent® provides the operational benefits of a larger roll towel dispenser in a compact and attractive design.

Controlled-Use Dispensing

Each pull of the exposed towel dispenses a single 11-inch towel to discourage waste and control cost. A locking cover prevents pilferage.

CONTROLLED ROLL TOWELS: **SPECIFICATIONS**

No.	Name	Color	Roll Width	Feet/Roll	Rolls/Case	Feet/Case	Cases/Unit	Cases/ Even Layer	Average Case Cube
31040	 DublNature®	White	8"	1,000	6	6,000	55	5	1.91
31000	 EcoSoft™	Natural	8"	1,000	6	6,000	55	5	1.81
38040	 DublNature®	White	8"	800	6	4,800	55	5	1.91
31300	 EcoSoft™	Natural	8"	800	6	4,800	55	5	1.81
31400	 EcoSoft™	Natural White	8"	800	6	4,800	55	5	1.81
30620	 Artisan™	White	8"	600	6	3,600	55	5	1.91
36040	 DublNature®	White	8"	600	6	3,600	55	5	1.91
30320	 Artisan™	White	8"	425	6	2,550	55	5	1.91
31900	EcoSoft™	White	8"	800	6	4,800	55	5	1.81
31500	EcoSoft™	Natural	8"	630	6	3,780	55	5	1.86
31600	EcoSoft™	White	8"	630	6	3,780	55	5	1.86
Dispenser Series: Wave'n Dry® (80010), OptiServ Hybrid® (87510), OptiServ® (86800)									
31060	 EcoSoft™	Natural	8"	550	6	3,300	88	8	1.16
34540	 DublNature®	White	8"	450	12	5,400	48	8	2.13
21400	 EcoSoft™	Natural White	8"	425	12	5,100	48	8	2.22
20100	EcoSoft™	Natural	8"	425	12	5,100	48	8	2.22

Dispenser Series: OptiServ Accent® (86600), Wave'n Dry® (80010), OptiServ Hybrid® (87510), OptiServ® (86800)

HAND HYGIENE: **PAPER TOWELS** VS. AIR DRYERS



The World Health Organization (WHO) and Centers for Disease Control and Prevention (CDC) recommend hands be washed 40-60 seconds and thoroughly dried using a paper towel. To prevent potential cross-contamination, use the paper towel to turn off the water faucet.²

Myth:

Warm air and jet air dryers are **more hygienic** than paper towels.

Did you know?

Warm air dryers **increase** the number of bacteria on fingertips and palms by up to 254%.¹

Jet air dryers **increase** the number of bacteria on both the palms and fingertips by up to 42%.¹

Fact:

Using paper towels after washing hands **reduces the number of bacteria** both on the palms and fingertips by up to 77%.¹

Myth:

Warm air and jet air dryers are **less likely to contaminate** the washroom environment.

Did you know?

Warm air dryers are capable of blowing bacteria and potentially contaminating the washroom up to **nine inches away**.¹

Jet air dryers that claim to blow air out of the unit at speeds of 400 mph are capable of blowing bacteria up to **six feet away**, potentially contaminating the washroom and other occupants.¹

Fact:

Using paper towels after washing hands showed **no significant potential of cross-contamination**.¹

¹Comparison of the Drying Efficiency and Hygiene of Paper Towels with Electric Hand Dryers, prepared by Keith Redway and Shameem Fawdar, School of Biosciences, University of Westminster, London, 2008.

²World Health Organization, Guidelines on Hand Hygiene in Health Care (www.who.int/gpsc/en), 2009; Centers for Disease Control and Prevention (www.cdc.gov/cleanhands), 2008.



CONTROLLED ROLL TOWEL DISPENSING SYSTEMS



89400
Compatible™ Button-Lever



89500
Compatible™ Lever

No.	Description	Translucent Color	Dispenser Size (W" x H" x D")	Dispenser Weight	Case Size (W" x H" x D")	Cases/Unit	Average Case Cube
89400	 Compatible™ Button-Lever	Black	11½ x 15⅝ x 10½	7.4 lbs.	11⅞ x 16 x 11¼	40	1.28
89500	 Compatible™ Lever	Black	11½ x 15⅝ x 10½	7.2 lbs.	11⅞ x 16 x 11¼	40	1.28

UNIVERSAL TOWEL DISPENSERS



No.	Description	Translucent Color	Dispenser Size (W" x H" x D")	Dispenser Weight	Case Size (W" x H" x D")	Cases/Unit	Average Case Cube
16000	Silhouette® Roll Towel	Black	10 ⁵ / ₈ x 15 ³ / ₄ x 8 ³ / ₄	6.7 lbs.	18 ¹ / ₈ x 10 ¹⁵ / ₁₆ x 10 ¹ / ₄	72	1.17
51000	Single Folded Towel	Steel Painted White	11 ³ / ₄ x 9 ¹ / ₄ x 5 ⁵ / ₈	4.6 lbs.	12 x 9 ⁵ / ₈ x 5 ³ / ₄	96	0.50
53200	Silhouette® Compact Towel	Black White Translucent: 53260	12 ³ / ₈ x 13 x 4 ⁷ / ₈	2.3 lbs.	12 ¹³ / ₁₆ x 13 ⁷ / ₈ x 5 ⁷ / ₁₆	189	0.56
53500	Silhouette® Folded Towel	Black White Translucent: 53560	12 ¹ / ₄ x 16 ³ / ₄ x 5	3.3 lbs.	13 ¹ / ₂ x 17 ¹ / ₄ x 5 ¹ / ₂	153	0.74
53800	OptiFold® ES Folded Towel	Black White Translucent: 53860	8 ¹ / ₂ x 10 ⁷ / ₁₆ x 3 ⁷ / ₈	1.25 lbs.	10 ¹ / ₂ x 9 ³ / ₃₂ x 4	336	0.26
68100	CenterPull	Black	10 x 12 ¹ / ₂ x 10	2.8 lbs.	11 x 13 ¹ / ₂ x 11	108	0.95

dublSERV^{HC}

REVOLUTION[®]

dublSERV^{vertical}

dublSERV^{side-by-side}

optiCORE[®]

CONTROLLED

BATH TISSUE

DISPENSING

SYSTEM

No.	80400
	
Description	Dubl-Serv® HC
Translucent Color	Black
Dispenser Size (W" x H" x D")	16 ⁵ / ₁₆ x 9 ¹⁵ / ₁₆ x 4 ³ / ₄
Dispenser Weight	2.8 lbs.
Case Size (W" x H" x D")	17 x 5 ³ / ₄ x 10 ⁵ / ₁₆
Cases/Unit	64
Average Case Cube	0.58
	80480

dublSERV[®] HC

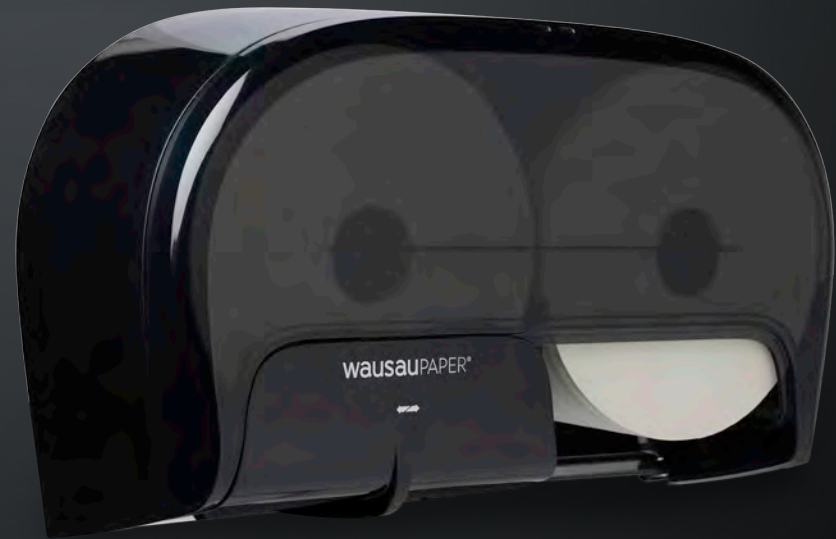

Highest Capacity OptiCore[®] System

The Dubl-Serv[®] HC provides a high-quality alternative to coreless and mini jumbo tissue dispensers. Designed to minimize waste and lower maintenance costs in the busiest washrooms, the Dubl-Serv[®] HC features patented OptiCore[®] technology in a dispenser with remarkable capacity.



Controlled Use

The Dubl-Serv® HC's patented OptiCore® design reduces waste and optimizes savings. Unlike coreless tissue that can leave behind stub roll waste, OptiCore® tissue requires one roll to be fully utilized before the next is accessible. Once a roll has been depleted, the core remains securely inside the dispenser, ensuring no cores are left on the floor or make their way into the plumbing system. The Dubl-Serv® HC features a sliding cover that securely protects both rolls and locks to prevent product pilferage.

Surprising Capacity in an Attractive Footprint

At less than 17" wide, the Dubl-Serv® HC delivers a total input capacity of 4,000 sheets of high-quality perforated tissue – more than twice that of traditional two roll dispensers – to extend the time between maintenance cycles and ensure continual supply. The Dubl-Serv® HC's dimensions afford flexible placement to ensure ADA compliance.







REVOLUTION®



High-Traffic OptiCore® Dispensing

The Revolution® dispensing system is designed to minimize maintenance and maximize cost savings for high-traffic areas. With its revolving design and our patented OptiCore® tissue, the Revolution® ensures that a roll is completely depleted before the dispenser will advance to the next roll, eliminating waste. Capacity for three OptiCore® tissue rolls allows for longer periods between maintenance. The Revolution® features a locking cover to prevent product pilferage and is available in five color choices.

No.	80300
	
Description	Revolution®
Translucent Color	Black
Dispenser Size (W" x H" x D")	14 ¹ / ₈ x 14 ⁹ / ₁₆ x 6 ⁵ / ₁₆
Dispenser Weight	3.6 lbs.
Case Size (W" x H" x D")	14 ⁷ / ₁₆ x 14 ¹¹ / ₁₆ x 6 ¹¹ / ₁₆
Cases/Unit	60
Average Case Cube	0.81

	80330
	80340
	80350
	80360

dublSERV® vertical



OptiCore® Dispensing for Smaller Spaces

The Dubl-Serv® vertical tissue dispenser is ideal for environments where horizontal space is limited. The Dubl-Serv® dispensing system holds two rolls of patented OptiCore® tissue and is designed to ensure the lower roll is completely utilized before the upper roll can be accessed, eliminating waste and controlling cost. The Dubl-Serv® features a locking cover to prevent product pilferage.

No.	82300
	
Description	Dubl-Serv® Vertical
Translucent Color	Black
Dispenser Size (W" x H" x D")	6 ³ / ₄ x 12 ⁵ / ₁₆ x 7
Dispenser Weight	2.0 lbs.
Case Size (W" x H" x D")	7 ¹ / ₄ x 12 ⁵ / ₁₆ x 7 ¹ / ₂
Cases/Unit	120
Average Case Cube	0.40

	82330
	82340
	82350
	82360

dublSERV[®] side-by-side

No.
80200



Description
Dubl-Serv[®]
Side-by-Side

Translucent Color
Black

Dispenser Size
(W" x H" x D")
11¹/₁₆ x 8¹³/₁₆ x 7⁷/₁₆

Dispenser Weight
2.2 lbs.

Case Size
(W" x H" x D")
11³/₈ x 8¹⁵/₁₆ x 7⁷/₈

Cases/Unit
102

Average
Case Cube
0.48



Traditional Footprint OptiCore[®] Dispensing

The Dubl-Serv[®] Side-by-Side tissue dispensing system holds two rolls of patented OptiCore[®] tissue. With a controlled use design, the Dubl-Serv[®] dispensing system reduces waste and cost by ensuring each roll is completely utilized before the next roll is accessible. The Dubl-Serv[®] Side-by-Side features a locking cover to prevent product pilferage.

	80230
	80240
	80250
	80260

optiCORE[®]



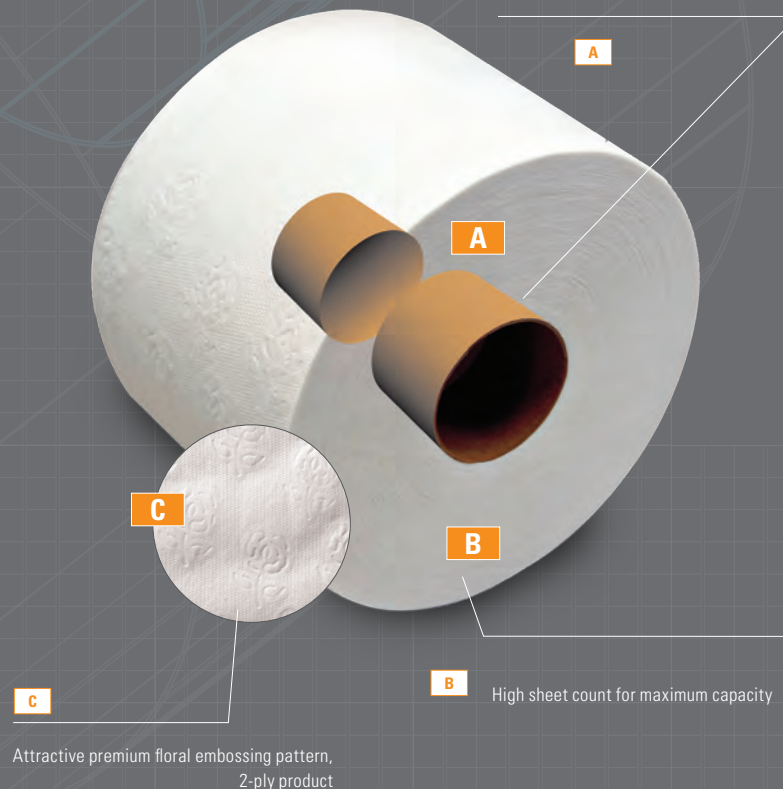

Wausau Paper offers patented OptiCore[®] technology, reducing maintenance time and costs.

Our OptiCore[®] technology, combined with our Revolution[®] and Dubl-Serv[®] dispensing systems, ensures maximum use of each roll in the dispenser before advancing to the next roll. This controlled-use reduces product waste and cost.

OptiCore[®] technology offers a two-part core for controlled-use and more than 25% reduction in core material for more environmentally preferable packaging.



OPTICORE® BATH TISSUE: SPECIFICATIONS

No.	Name	Ply	Sheet Size (W"x L")	Sheets/Roll	Rolls/Case	Sheets/Case	Cases/Unit	Cases/ Even Layer	Average Case Cube
60090	 EcoSoft™ High-Capacity	Double	3¾ x 3½	2,000	12	24,000	60	5	1.60
12990	 EcoSoft™	Single	3¾ x 4	1,755	36	63,180	48	6	2.74
61990	 EcoSoft™	Double	3¾ x 4	865	36	31,140	48	6	2.74
62040	 DublNature®	Fusion® Formation	3¾ x 4	865	36	31,140	48	6	2.54
62090	 DublNature®	Double	3¾ x 4	865	36	31,140	48	6	2.74
06390	DublSoft®	Double	3¾ x 4	800	36	28,800	48	6	2.74



DublSoft

DublSoft® premium OptiCore® 2-ply bath tissue is for those customers who demand the maximum in strength, brightness and softness. DublSoft® products will meet that demand. This tissue also offers an attractive premium embossing pattern that any customer can appreciate. DublSoft® packaging is designed for the most upscale applications and is an attractive addition to any décor.



DublNature®

DublNature® OptiCore® tissue offers superior quality with a stylish and sophisticated appearance. DublNature® products are made from a superior grade of 100% recycled wastepaper for exceptional brightness and overall quality. Featuring consumer-like embossing and environmentally preferable packaging, Green Seal™-certified DublNature® tissue is ideal for a wide range of applications.



EcoSoft™

EcoSoft™ OptiCore® bath tissue is certified as environmentally preferable by Green Seal, Inc., in Washington, DC. Made from 100% recycled fiber with a minimum of 25% post-consumer waste content, EcoSoft™ far exceeds the EPA guidelines. The tissue products also feature environmentally preferable packaging. Available in high-capacity or standard OptiCore® rolls.

UNIVERSAL BATH TISSUE DISPENSERS



72200
Dubl-Serv® 2-Roll Tissue







88700
Jumbo Roll Tissue



88800
9" Roll Tissue



88900
Side-by-Side 9" Roll Tissue

No.	Description	Translucent Color	Dispenser Size (W" x H" x D")	Dispenser Weight	Case Size (W" x H" x D")	Cases/Unit	Average Case Cube
72200	 Dubl-Serv®	Black	6 ⁵ / ₈ x 13 ¹ / ₈ x 6 ¹ / ₈	2.2 lbs.	6 ⁷ / ₈ x 13 ⁵ / ₈ x 6 ⁵ / ₈	105	0.40
88700	 Jumbo Roll Tissue	Black	13 ¹ / ₄ x 14 ¹⁵ / ₁₆ x 6	2.8 lbs.	13 ¹ / ₂ x 15 ⁹ / ₁₆ x 6 ¹ / ₈	60	0.82
88800	 9" Roll Tissue	Black	9 ⁵ / ₈ x 11 ¹ / ₈ x 5 ¹ / ₄	1.75 lbs.	10 ⁷ / ₈ x 12 x 6	84	0.45
88900	 Side-by-Side 9"	Black	22 x 13 ³ / ₈ x 5 ⁷ / ₈	4.4 lbs.	22 ³ / ₈ x 14 ³ / ₈ x 6 ⁷ / ₈	84	1.18



GREEN SEAL STANDARDS FOR HAND SOAPS (GS-41A)

- Must meet or exceed applicable governmental and industrial safety
- Cannot be a skin sensitizer or skin irritant
- No antibacterial, disinfecting, antiseptic or sanitizing product claims can be made
- Cannot be formulated or manufactured with phosphates, NTA, EDTA, APEOs, halogenated organic solvents, butoxy-ethanol, or with any chemicals that are proven, probable, or possible carcinogens
- Fragrances used must be produced or handled following the code of practice of the International Fragrance Association; fragrances must be declared on the product label and MSDS sheets
- Can only be formulated or manufactured with food grade dyes
- Cannot contain volatile organic compounds in excess of 1%
- Based on standard use, hand cleaners cannot be toxic to aquatic life and must be readily biodegradable
- Must include detailed instructions for proper use to maximize product performance and minimize waste
- Must not be packaged in a bag in box packaging
- Packaging must be recyclable (an exception shall be made for lightweight flexible packaging, such as pouches or bags, that represent at least 20% reduction in material use when compared with rigid packaging); efforts must be made to ensure packaging contains post-consumer recycled content

OPTISOURCE® INSTANT HAND SANITIZING FOAM VS. ALCOHOL SANITIZING GEL

	OPTISOURCE® NON-ALCOHOL FOAM	ALCOHOL GEL
CDC recommended	✓	✓
Kills 99.9% of harmful germs on hands in 15 seconds	✓	✓
Kills H1N1, rhinovirus, E coli, and MRSA	✓	✓
Kills Clostridium difficile (C diff)	✓	✗
FDA compliant	✓	✓
NSF-E3 approved for food handlers	✓	✓
Benzalkonium chloride .01% formula reduces bacteria on hands while it preserves natural protective oils	✓	✗
Safe for healthcare workers and public areas where non-flammable sanitizers are required	✓	✗
Gentle on eyes and skin	✓	✗
Won't stain clothes or floors	✓	✗
Repeated use keeps your hands clean, soft, and moisturized - not dry, red and irritated	✓	✗
Protects hands against germs for up to four hours	✓	✗

opti**SOURCE** convertible®

opti**SOURCE**®

SILHOUETTE®

HAND CARE SYSTEM



12501 Lotion Soap

This rich, Green Seal™-certified lotion soap provides superior cleaning and leaves skin soft and moisturized. It is excellent for use in office buildings as well as healthcare, educational, industrial, and recreational facilities.

- Pre-measured dose: 1.0mL
- 1250mL cartridge capacity
- Fits OptiSource Convertible® electronic or manual dispensers



12502 Instant Hand Sanitizer

The fast-acting OptiSource® Instant Foam Hand Sanitizer kills 99.9% of germs that cause illness and can be used without water.

- OptiSource® sanitizers provide 2-4 hours of ongoing protection
- Benzalkonium Chloride-based sanitizer will not over-dry and irritate skin like alcohol-based sanitizers



12503 Foam Lotion Soap

Ideal for those who prefer the convenience of having soap pre-lathered before washing, this gentle Green Seal™-certified foam lotion soap provides a convenient and pleasing hand washing experience.



- Pre-measured dose: 0.75mL
- 1250mL cartridge capacity
- Fits OptiSource Convertible® electronic or manual dispensers



12504 Antibacterial Soap

This OptiSource® antibacterial foam hand soap produces a non-sticky foam that contains unique non-drying, conditioning and moisturizing ingredients. This leaves skin feeling soft, refreshed and silky, while killing 99.9% of germs that cause illness.

- Pre-measured dose: 0.75mL
- Triclosan Free and NSF E2 registered
- Contains 0.13% Benzalkonium Chloride to effectively eliminate bacteria

No.	Description	Color	Cartridge Capacity	Items/Case	Cases/Unit	Cases/ Even Layer	Average Case Cube
12501	 OptiSource® Lotion Soap	White	1250mL	4	100	20	0.50
12502	OptiSource® Sanitizing Foam	White	1250mL	4	100	20	0.50
12503	 OptiSource® Foam Lotion Soap	White	1250mL	4	100	20	0.50
12504	 OptiSource® Antibacterial Foam Soap	White	1250mL	4	100	20	0.50

OptiSource® Products for Dispenser Series: OptiSource Convertible® Manual (91210), OptiSource Convertible® Electronic (91218)

optiSOURCE convertible®

ELECTRONIC







OptiSource Convertible® Electronic

For the ultimate in cleanliness, the electronic OptiSource Convertible® eliminates the need to touch dispensers so hands are not cross-contaminated. When installed according to ADA guidelines, this dispenser is ADA Title III compliant.

- Pre-measured dose: 1.0mL lotion, 0.75mL foam
- Adjustable setting for sensor, dose and speed
- Locking cover prevents product pilferage
- Estimated battery life expectancy 9-12 months dependent upon usage

No.	91218
	
Description	OptiSource Convertible® Electronic
Translucent Color	Black
Dispenser Size (W" x H" x D")	6 ¹ / ₁₆ x 11 ¹ / ₈ x 4
Dispenser Weight	1.6 lbs.
Case Size (W" x H" x D")	13 ³ / ₁₆ x 12 ³ / ₁₆ x 14 ⁵ / ₁₆
Item/Case	6
Cases/Unit	84
Average Case Cube	1.33

	91238
	91248
	91258
	91268

optiSOURCE convertible®

MANUAL

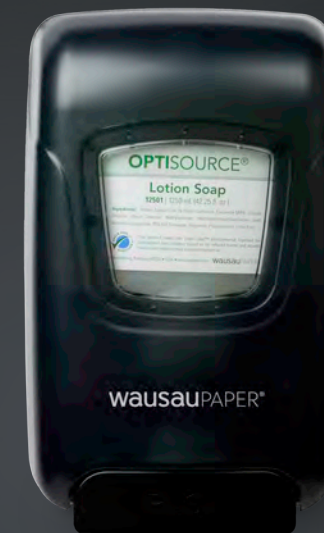





OptiSource Convertible® Manual

The manual OptiSource Convertible® has a durable design and can be used with foam or liquid soap cartridges. It is ADA Title III compliant when installed according to ADA guidelines.

- Pre-measured dose: 1.0mL lotion, 0.75mL foam
- Large push bar for easy activation
- Locking cover to prevent product pilferage
- Can convert to electronic touch-free

No.	91210
	
Description	OptiSource Convertible® Manual
Translucent Color	Black
Dispenser Size (W" x H" x D")	6 ¹ / ₁₆ x 11 ¹ / ₈ x 4
Dispenser Weight	1.6 lbs.
Case Size (W" x H" x D")	13 ³ / ₁₆ x 12 ³ / ₁₆ x 14 ⁵ / ₁₆
Item/Case	6
Cases/Unit	84
Average Case Cube	1.33

	91230
	91240
	91250
	91260

OPTISOURCE® HAND CARE SYSTEM

Lotion Soap and Foam Lotion Soap

- Ideal for multipurpose use in washrooms
- Replaces expensive, unsanitary bar soap and low-quality liquid and powder soaps
- Certified by Green Seal, Inc.

Foam Antibacterial Soap



- Contains 0.3% Triclosan to effectively kill the broadest possible spectrum of bacteria
- Provides superior skin cleansing to control noscomial infection
- Rich emollients soften skin and prevent drying and irritation
- FDA compliant



OptiSource® Soap Dispenser

No.	Description	Dispenser Size (W" x H" x D")	Dispenser Weight	Case Size (W" x H" x D")	Dispensers/Case	Cases/Unit	Average Case Cube		
91000	 OptiSource®	4¾ x 10 x 3½	0.75 lbs.	12¾ x 11¾ x 20	12	48	1.60		
Black Translucent: 91000		Red Translucent: 91030		Green Translucent: 91040		Blue Translucent: 91050		White Translucent: 91060	

OptiSource® Soap Products

No.	Description	Color	Cartridge Capacity	Items/Case	Cases/Unit	Cases/Even Layer	Average Case Cube
91100	 OptiSource® Lotion Soap	White	1000mL	8	75	15	0.65
91300	 OptiSource® Foam Lotion Soap	White	1000mL	4	160	32	0.30
91400	 OptiSource® Antibacterial Foam Soap	White	1000mL	4	160	32	0.30



Drip Tray: 18329
Dispenser Stand: 18140

SILHOUETTE® HAND CARE SYSTEM



95270
Silhouette® 500mL



95100 • 95150
Silhouette® Soap Products

Silhouette® Soap Dispenser

No.	Description	Color	Dispenser Size (W" x H" x D")	Dispenser Weight	Case Size (W" x H" x D")	Dispensers/Case	Cases/Unit	Average Case Cube
95270	 Silhouette®	Black	4¾ x 7¼ x 4½	1.2 lbs.	16¼ x 8¾ x 11	6	80	1.04

Silhouette® 500mL Soap Products

95100	 Lotion Soap	White	500mL	12	140	20	0.42
95150	 E2 Antibacterial Skin Cleanser	White	500mL	12	140	20	0.42

Silhouette® 1200mL Soap Products (for use with Silhouette® 92000 Dispenser)

No.	Description	Color	Cartridge Capacity	Items/Case	Cases/Unit	Cases/Even Layer	Average Case Cube
92100	 Lotion Soap (not pictured)	White	1200mL	8	72	12	0.51
92400	Antibacterial Lotion Soap (not pictured)	White	1200mL	8	72	12	0.51



Most Wausau Paper dispensers are ADA Title III compliant when installed according to ADA guidelines. Product is easily dispensed with one hand, with less than 5 lbs. of force, and without tight grasping, pinching or twisting of the wrist.

Forward Reach for Wall Mounted Dispensers

308.2.1 Where a forward reach is unobstructed, the high forward reach shall be 48 inches (1220mm) maximum and the low forward reach shall be 15 inches (3810mm) minimum above the finish floor or ground. [Section 308.2.1, ADA Accessibility Guidelines]

308.2.2 Where a high forward reach is over an obstruction, the clear floor space shall extend beneath the element for a distance not less than the required reach depth over the obstruction.

The high forward reach shall be 48 inches (1220mm) maximum where the reach depth is 20 inches (510mm) maximum. Where the reach depth exceeds 20 inches (510mm), the high forward reach shall be 44 inches (1120mm) maximum and the reach depth shall be 25 inches (635mm) maximum. [Section 308.2.2, ADA Accessibility Guidelines]

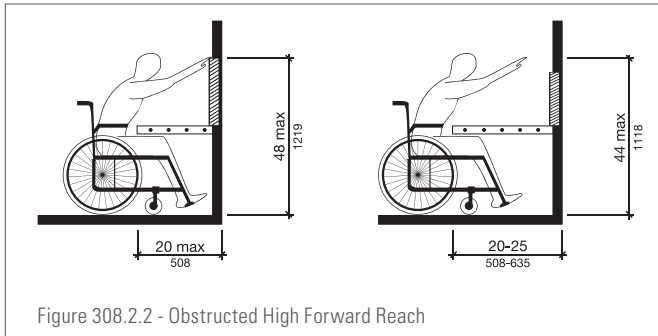

Figure 308.2.2 - Obstructed High Forward Reach

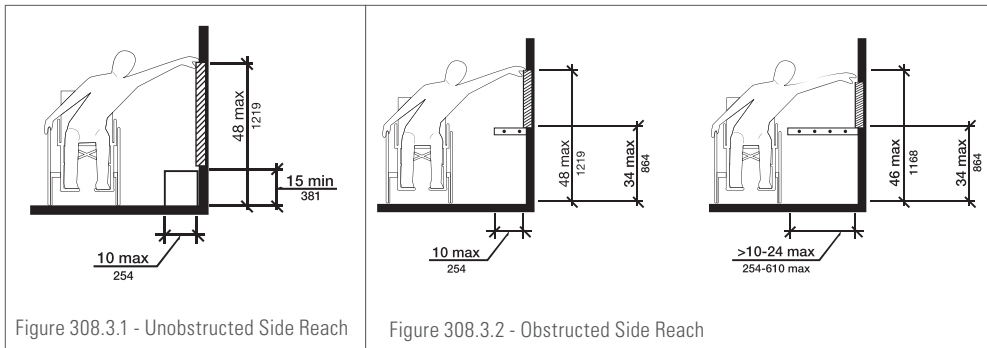

Figure 308.3.1 - Unobstructed Side Reach

Figure 308.3.2 - Obstructed Side Reach

Dispenser Installation in Water Closets and Toilet Compartments

604.7 Toilet paper dispensers shall comply with section 309.4 and shall be 7 inches (180mm) minimum and 9 inches (230mm) maximum in front of the water closet measured to the centerline of the dispenser. The outlet of the dispenser shall be 15 inches (380mm) minimum and 48 inches (1220mm) maximum above the finish floor and shall not be located behind grab bars. Dispensers shall not be of a type that controls delivery or that does not allow continuous paper flow. [Section 604.7, ADA Accessibility Guidelines]

ADVISORY 604.7 If toilet paper dispensers are installed above the side wall grab bar, the outlet of the toilet paper dispenser must be 48 inches (1220mm) maximum above the finish floor and the top of the gripping surface of the grab bar must be 33 inches (840mm) minimum and 36 inches (915mm) maximum above the finish floor.

Dispenser Installation and Side Reach Obstructions

308.3.1 Where a clear floor or ground space allows a parallel approach to an element and the side reach is unobstructed, the high side reach shall be 48 inches (1220mm) maximum and the low side reach shall be 15 inches (380mm) minimum above the finish floor or ground.

EXCEPTION

An obstruction shall be permitted between the clear floor or ground space and the element where the depth of the obstruction is 10 inches (255mm) maximum.

308.3.2 Where a clear floor or ground space allows a parallel approach to an element and the high side reach is over an obstruction, the height of the obstruction shall be 34 inches (865mm) maximum and the depth of the obstruction shall be 24 inches (610mm) maximum.

The high side reach shall be 48 inches (1220mm) maximum for a reach depth of 10 inches (255mm) maximum.

Where the reach depth exceeds 10 inches (255mm), the high side reach shall be 46 inches (1170mm) maximum for a reach depth of 24 inches (610mm) maximum. [Section 308.3, ADA Accessibility Guidelines]

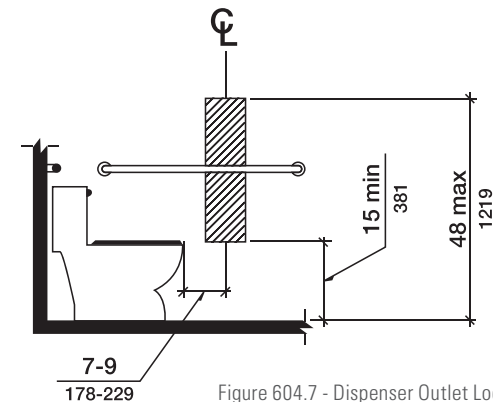

Figure 604.7 - Dispenser Outlet Location

Index by Catalog Number

No.	Description	Pg.	No.	Description	Pg.	No.	Description	Pg.
02001	EcoSoft™ Universal Jumbo Tissue.....	23	14800	EcoSoft™ Universal Bath Tissue.....	23	40700	Sirrus® Household Roll Towels.....	27
03351	Multi Dubl-Tough® Premium Wiper.....	25	15000	EcoSoft™ Facial Tissue.....	22	40900	Sirrus® Household Roll Towels.....	27
03352	Multi Dubl-Tough® Economy Wiper.....	25	16000	Silhouette® Roll Towel Universal Towel Dispenser.....	35	41000	EcoSoft™ Household Roll Towel.....	21
03356	Multi Dubl-Tough® Economy Wiper.....	25	18140	Soap Dispenser Stand.....	48	41080	EcoSoft™ Household Roll Towel.....	21
03362	Mighty Dry Dubl-Tough® Wiper.....	25	18329	Dip Tray.....	48	41090	EcoSoft™ Household Roll Towel.....	21
03380	Ultra Dubl-Tough® DRC Wiper.....	25	19490	EcoSoft™ Toilet Seat Cover.....	22	41859	EcoSoft™ Household Roll Towel.....	21
04220	Artisan™ Multifold Towel.....	11	19510	Silhouette® Toilet Seat Dispenser.....	22	44040	DublNature® Universal Roll Towel.....	15
04420	Artisan™ OptiFold® Towel.....	11	20020	EcoSoft™ Universal Jumbo Tissue.....	23	44840	DublNature® Universal Roll Towel.....	15
04620	Artisan™ OptiFold® ES Towel.....	11	20100	EcoSoft™ Controlled Roll Towel.....	19,32	45500	EcoSoft™ Universal Roll Towel.....	20
04820	Artisan™ C-Fold Towel.....	11	21400	EcoSoft™ Controlled Roll Towel.....	19,32	45600	EcoSoft™ Universal Roll Towel.....	20
06002	EcoSoft™ Center Pull Roll Towel.....	19	25000	Dari-Towls® (2-Ply).....	26	45700	EcoSoft™ Universal Roll Towel.....	20
06100	DublSoft® Facial Tissue Flat Box.....	13	25200	EcoSoft™ Controlled Roll Towel.....	19	45800	EcoSoft™ Universal Roll Towel.....	20
06185	DublSoft® Facial Tissue Cube Box.....	13	30320	Artisan™ Controlled Roll Towel.....	11,32	45900	EcoSoft™ Universal Roll Towel.....	20
06325	DublSoft® Controlled Bath Tissue.....	13	30620	Artisan™ Controlled Roll Towel.....	11,32	46000	EcoSoft™ Universal Roll Towel.....	20
06348	DublSoft® Bath Tissue.....	13	31000	EcoSoft™ Controlled Roll Towel.....	19,32	46200	EcoSoft™ Universal Roll Towel.....	20
06380	DublSoft® Bath Tissue.....	13	31040	DublNature® Controlled Roll Towel.....	15,32	46300	EcoSoft™ Universal Roll Towel.....	20
06390	DublSoft® OptiCore®.....	13,42	31060	EcoSoft™ Controlled Roll Towel.....	19,32	46500	EcoSoft™ Universal Roll Towel.....	20
06480	DublSoft® Bath Tissue.....	13	31300	EcoSoft™ Controlled Roll Towel.....	19,32	46800	EcoSoft™ Universal Roll Towel.....	20
08540	DublNature® Cube Facial.....	16	31400	EcoSoft™ Controlled Roll Towel.....	19,32	46900	EcoSoft™ Universal Roll Towel.....	20
10000	EcoSoft™ Universal Bath Tissue.....	23	31500	EcoSoft™ Controlled Roll Towel.....	19,32	47000	EcoSoft™ Singlefold Towel.....	21
10020	EcoSoft™ Universal Jumbo Tissue.....	23	31600	EcoSoft™ Controlled Roll Towel.....	19,32	47010	Dari-Towls® Natural.....	26
10040	DublNature® Flat Facial.....	16	31900	EcoSoft™ Controlled Roll Towel.....	19,32	47300	EcoSoft™ Singlefold Towel.....	21
11500	EcoSoft™ Universal Bath Tissue.....	23	34000	Dari-Towls® Pre-Dip.....	26	47500	EcoSoft™ Singlefold Towel.....	21
12300	EcoSoft™ Controlled Bath Tissue.....	22	34540	DublNature® Controlled Roll Towel.....	15,32	48140	DublNature® Multifold Towel.....	15
12501	OptiSource® Lotion Soap.....	46	35000	Dari-Towls® Natural.....	26	48300	EcoSoft™ Multifold Towel.....	21
12502	OptiSource® Sanitizing Foam.....	46	36000	Dari-Towls® Natural.....	26	48440	DublNature® OptiFold® Towel.....	15
12503	OptiSource® Foam Lotion Soap.....	46	36040	DublNature® Controlled Roll Towel.....	15,32	48500	EcoSoft™ Multifold Towel.....	21
12504	OptiSource® Antibacterial Foam Soap.....	46	38040	DublNature® Controlled Roll Towel.....	15,32	48640	DublNature® OptiFold® ES Towel.....	15
12990	EcoSoft™ OptiCore®.....	22,42	39000	Dari-Towls® Natural White.....	26	48790	EcoSoft™ OptiFold® ES Towel.....	21
13000	EcoSoft™ Facial Tissue.....	22	40000	EcoSoft™ Household Roll Towel.....	21	48890	EcoSoft™ OptiFold® Towel.....	21
13400	Singlwipes® Windshield Towels.....	27	40010	EcoSoft™ Universal Jumbo Tissue.....	23	49140	DublNature® C-Fold Towel.....	15
14000	EcoSoft™ Universal Bath Tissue.....	23	40090	EcoSoft™ Household Roll Towel.....	21	49300	EcoSoft™ C-Fold Towel.....	21

No.	Description	Pg.	No.	Description	Pg.	No.	Description	Pg.
49500	EcoSoft™ C-Fold Towel.....	21	80200	Dubl-Serv® Side-by-Side Black Bath Tissue Dispenser.....	41	88700	Jumbo Roll Tissue Universal Bath Tissue Dispenser.....	43
50000	EcoSoft™ Universal Bath Tissue	23	80230	Dubl-Serv® Side-by-Side Red Bath Tissue Dispenser.....	41	88800	9" Roll Tissue Universal Bath Tissue Dispenser	43
50080	EcoSoft™ Universal Bath Tissue	23	80240	Dubl-Serv® Side-by-Side Green Bath Tissue Dispenser.....	41	88900	Side-by-Side 9" Universal Bath Tissue Dispenser	43
50940	DublNature® Fusion® Universal Bath Tissue	16	80250	Dubl-Serv® Side-by-Side Blue Bath Tissue Dispenser.....	41	89400	Compatible™ Button-Lever Controlled Towel Dispenser.....	34
51000	Single Folded Towel Universal Towel Dispenser	35	80260	Dubl-Serv® Side-by-Side White Bath Tissue Dispenser.....	41	89500	Compatible™ Lever Controlled Towel Dispenser.....	34
52500	Twinwipes® Windshield Towels	27	80300	Revolution® Black Bath Tissue Dispenser.....	40	91000	OptiSource® Soap Dispenser	48
53000	Twinwipes® Windshield Towels	27	80330	Revolution® Red Bath Tissue Dispenser	40	91100	OptiSource® Lotion Soap	48
53200	Silhouette® Compact Universal Towel Dispenser	35	80340	Revolution® Green Bath Tissue Dispenser.....	40	91210	OptiSource Convertible® Black Manual Soap Dispenser.....	47
53500	Silhouette® Folded Universal Towel Dispenser	35	80350	Revolution® Blue Bath Tissue Dispenser.....	40	91218	OptiSource Convertible® Black Electronic Soap Dispenser ..	47
53800	OptiServ® ES Folded Towel Dispenser	35	80360	Revolution® White Bath Tissue Dispenser.....	40	91230	OptiSource Convertible® Red Manual Soap Dispenser.....	47
54000	EcoSoft™ Universal Bath Tissue	23	80400	Dubl-Serv® HC Black Bath Tissue Dispenser	38	91238	OptiSource Convertible® Red Electronic Soap Dispenser.....	47
54800	EcoSoft™ Universal Bath Tissue	23	80480	Dubl-Serv® HC White Bath Tissue Dispenser.....	38	91240	OptiSource Convertible® Green Manual Soap Dispenser.....	47
54900	EcoSoft™ Universal Bath Tissue	23	82300	Dubl-Serv® Vertical Black Bath Tissue Dispenser.....	40	91248	OptiSource Convertible® Green Electronic Soap Dispenser ..	47
55040	DublNature® Fusion® Universal Bath Tissue	16	82330	Dubl-Serv® Vertical Red Bath Tissue Dispenser.....	40	91250	OptiSource Convertible® Blue Manual Soap Dispenser.....	47
55440	DublNature® Fusion® Universal Bath Tissue	16	82340	Dubl-Serv® Vertical Green Bath Tissue Dispenser.....	40	91258	OptiSource Convertible® Blue Electronic Soap Dispenser...	47
55840	DublNature® Fusion® Universal Bath Tissue	16	82350	Dubl-Serv® Vertical Blue Bath Tissue Dispenser.....	40	91260	OptiSource Convertible® White Manual Soap Dispenser.....	47
59490	DublNature® Universal Bath Tissue	16	82360	Dubl-Serv® Vertical White Bath Tissue Dispenser.....	40	91268	OptiSource Convertible® White Electronic Soap Dispenser ..	47
59890	DublNature® Universal Bath Tissue	16	86600	OptiServ Accent® Black Controlled Towel Dispenser.....	31	91300	OptiSource® Foam Lotion Soap	48
60040	DublNature® CenterPull Roll Towel.....	15	86630	OptiServ Accent® Red Controlled Towel Dispenser	31	91400	OptiSource® Antibacterial Foam Soap.....	48
60090	EcoSoft™ High-Capacity OptiCore®.....	22,42	86640	OptiServ Accent® Green Controlled Towel Dispenser.....	31	92100	Lotion Soap	49
61600	EcoSoft™ Controlled Bath Tissue.....	22	86650	OptiServ Accent® Blue Controlled Towel Dispenser	31	92400	Antibacterial Lotion Soap	49
61990	EcoSoft™ OptiCore®.....	22,42	86660	OptiServ Accent® White Controlled Towel Dispenser	31	95100	Lotion Soap.....	49
62040	DublNature® Fusion® OptiCore®	16,42	86800	OptiServ® Black Controlled Towel Dispenser	31	95150	E2 Antibacterial Skin Cleanser	49
62090	DublNature® OptiCore®	16,42	86830	OptiServ® Red Controlled Towel Dispenser.....	31	95270	Silhouette® 500mL Soap Dispenser.....	49
68100	CenterPull Towel Dispenser.....	35	86840	OptiServ® Green Controlled Towel Dispenser	31			
72200	Dubl-Serv® Black Universal Bath Tissue Dispenser	43	86850	OptiServ® Blue Controlled Towel Dispenser.....	31			
80010	Wave'n Dry® Black Controlled Towel Dispenser.....	30	86860	OptiServ® White Controlled Towel Dispenser.....	31			
80020	Wave'n Dry® Black Water Resistant Towel Dispenser.....	30	87510	OptiServ Hybrid® Black Controlled Towel Dispenser.....	30			
80030	Wave'n Dry® Red Controlled Towel Dispenser	30	87530	OptiServ Hybrid® Red Controlled Towel Dispenser	30			
80040	Wave'n Dry® Green Controlled Towel Dispenser.....	30	87540	OptiServ Hybrid® Green Controlled Towel Dispenser.....	30			
80050	Wave'n Dry® Blue Controlled Towel Dispenser	30	87550	OptiServ Hybrid® Blue Controlled Towel Dispenser	30			
80060	Wave'n Dry® White Controlled Towel Dispenser	30	87560	OptiServ Hybrid® White Controlled Towel Dispenser	30			

Availability and specifications are subject to change.

Wausau PAPER®

